

3250CL

SETUP & OPERATOR MANUAL

Performance Design Inc. | 2350 East Braniff St. | Boise, Idaho 83716

www.Rhin-O-Tuff.com

Pro Series 3250CL



Features:

- 11" Punching Edge
- 25 Sheet Capacity**
- Book Former
- Easy to Use Coiler
- 3-Year Limited Warranty



Features

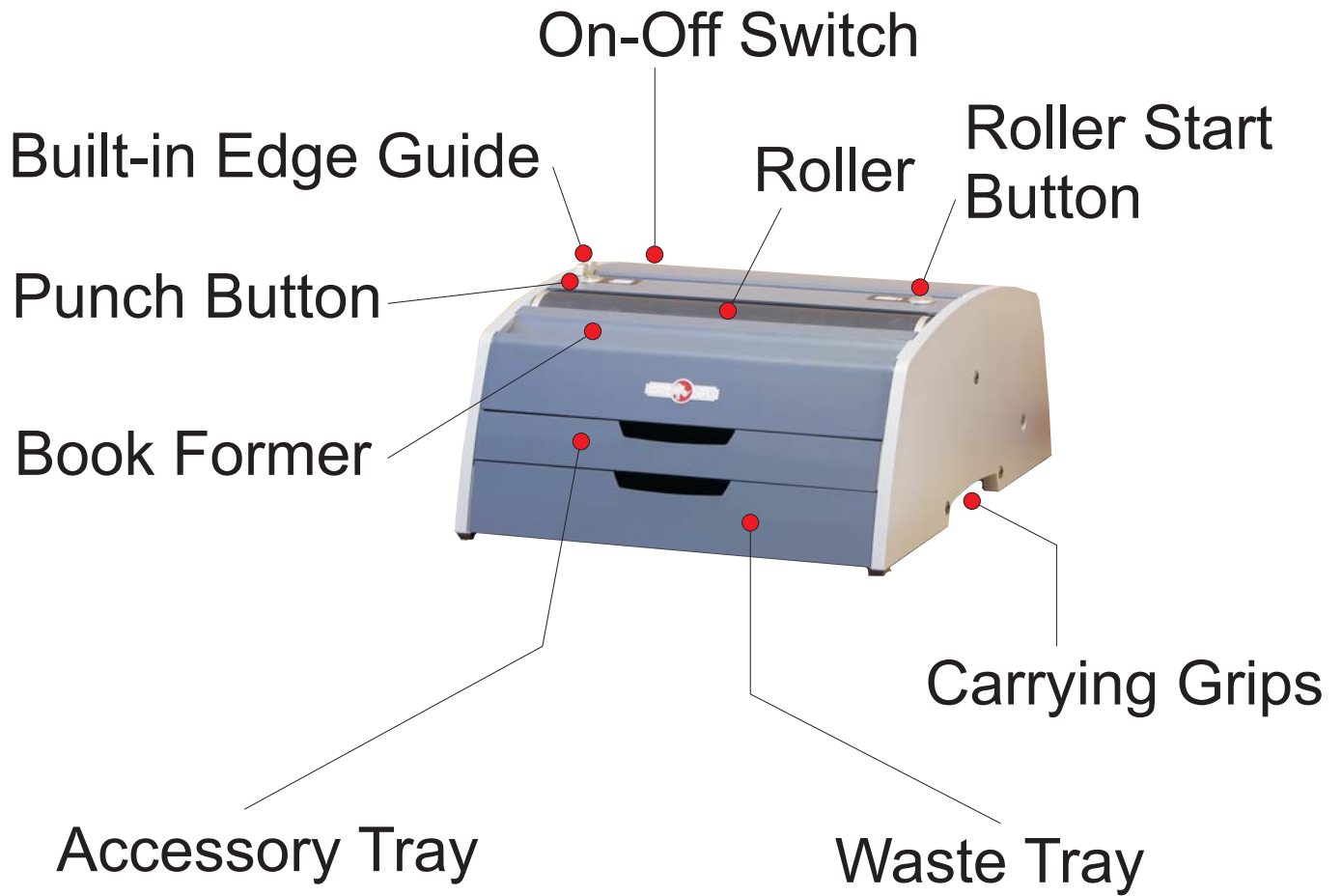

Capabilities & Specifications



Important Safety Notice

- Always replace fuses or circuit breakers with the correct amperage and type.



- Never bypass safety devices.
- Hazardous voltages inside of machine.
- No user serviceable parts inside of machine. Machine should only be opened by qualified repair personnel.

Punch Capacity

20lb Copy Paper	25 Sheets
8mil Acetate Cover	2 Sheets

Binding Capacity

Max Coil Size Recommended	15mm
Max Sheets Recommended	110 Sheets

Technical Data

Punch Die Pattern	4:1 .2475" spacing [.172" dia.]
Paper Size	8 1/2" x 11" & 5 1/2" x 8 1/2"
Voltage	120V AC 60Hz
Current	4A
Punch Duty Cycle	2 Min. Run / 1 Min Rest
Shipping weight / Machine weight	45lbs / 42lbs
Dimension (LxDxH)	14" x 17" x 7"



Setup

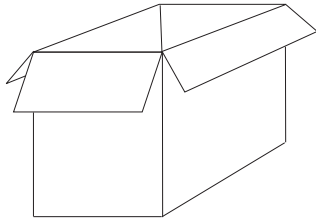

Unpackage machine

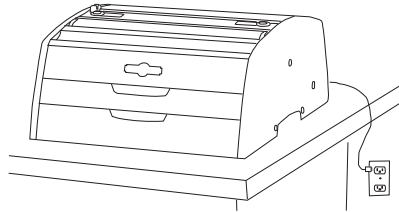

- Position machine on solid surface
- Plug power cord into wall outlet

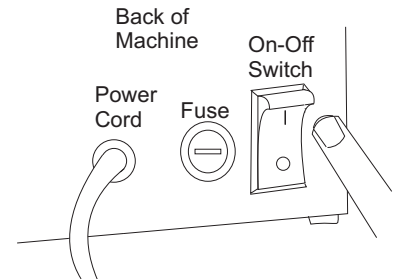

Turn power switch on

Punch

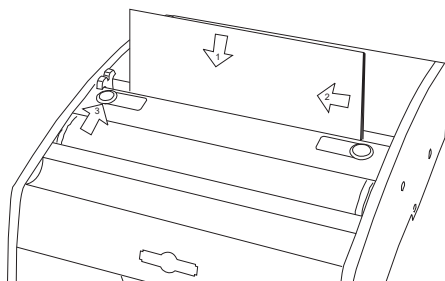

- Insert paper, slide left, press punch button
- Punch no more than 25 sheets of paper at one time
- Punch no more than 2 sheets of plastic at one time

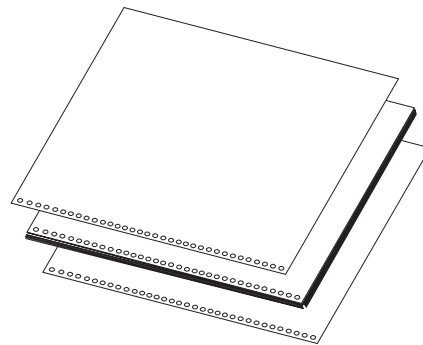

Prepare book to be coiled by placing the Front Cover on top and the Back Cover on the bottom of the Book Body

Coil

Determine the coil size needed by measuring the book thickness with guide on right side of the accessory tray.

Move book from larger to smaller sizes until book just fits between guides.

The number associated with the slot (i.e. 8mm) signifies what size of coil to use.

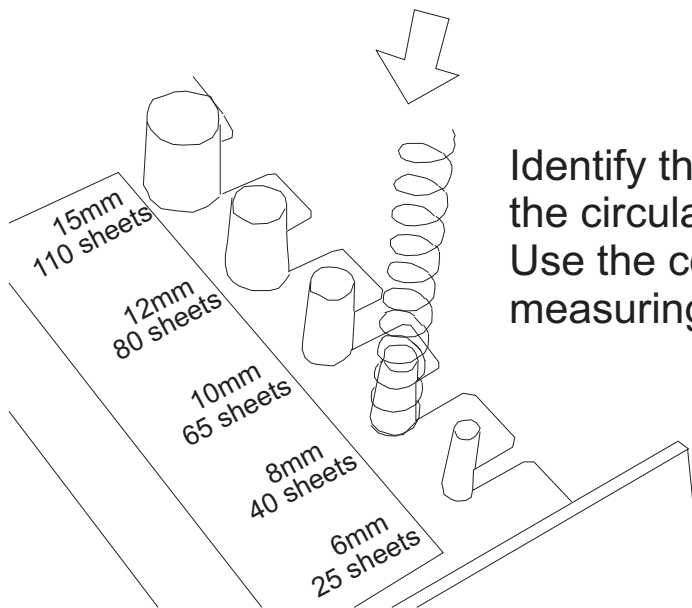
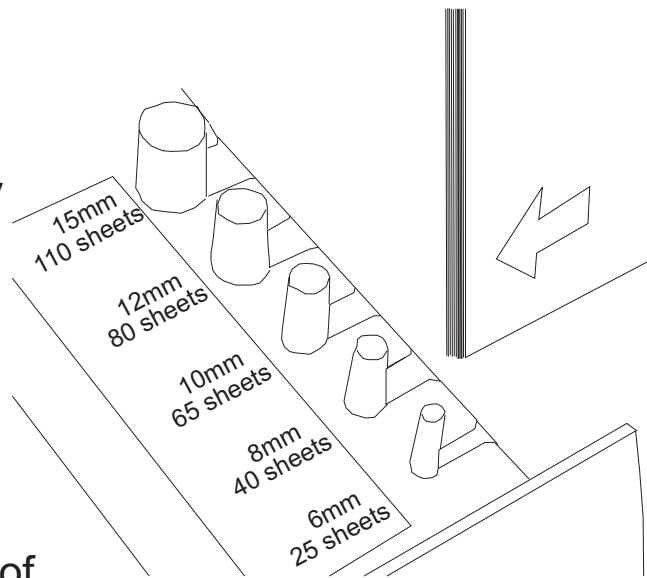

Identify the size of coil by sliding coils over the circular pegs starting from small to large. Use the coil that fits on the peg found by measuring the book thickness in previous step.

Coil

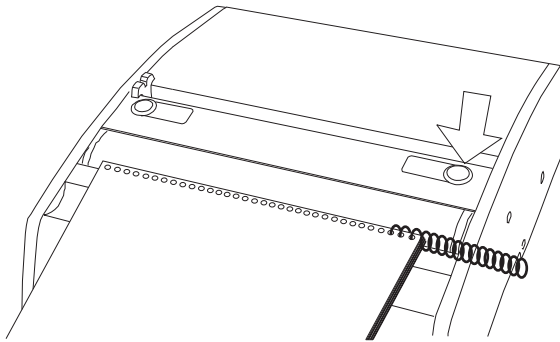

- Manually start Coil into the first 3-4 holes on right hand side of book
- Press Coil Button to start roller spinning
- Gently bring the coil into contact with the front side of the spinning roller while holding the book in a horizontal plane as shown above
- Allow coil to spin into the book

Crimping

- Position pliers with the RED dot facing up, to the ceiling as shown
- Holding pliers horizontally, insert the plier tips around the last coil of the book on the right hand side of the book
- Close pliers completely; this will cut and crimp the coil

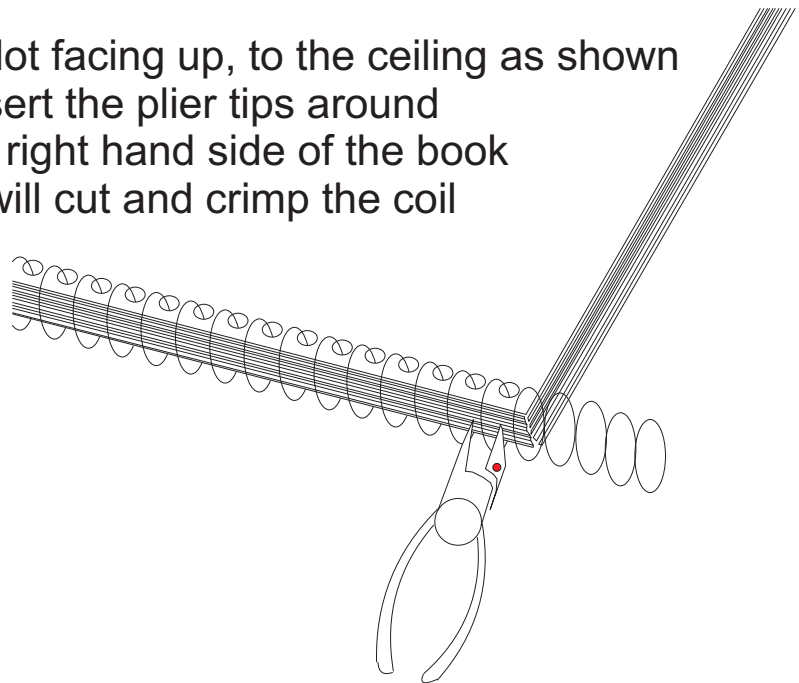

Crimping

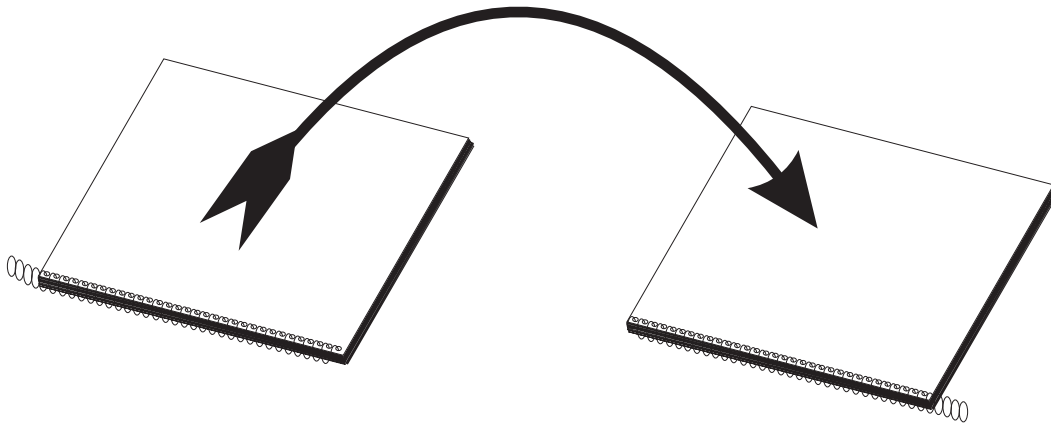

Flip the entire book over so that the back cover is now on top

- Position pliers with the RED dot facing up, to the ceiling as shown
- Holding pliers horizontally, insert the plier tips around the last coil of the book on the right hand side of the book
- Close pliers completely; this will cut and crimp the coil

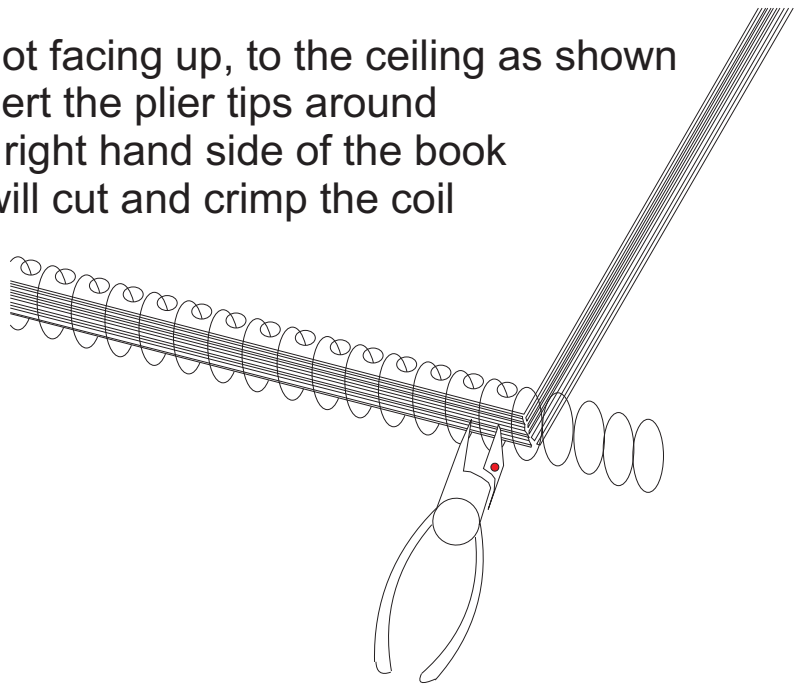

Troubleshooting

Symptom

Solution

Machine will not punch holes in paper

- Plug power cord into wall outlet
- Check wall outlet has power
- Switch machine power switch to the “on” position

Holes punch on the edge of paper

- Clear paper chips from the throat of the punch die
- Seat paper completely into the bottom of the punch die

Holes punch off center of page

- Move paper to the left, against the paper stop, prior to pressing the punch button

Punch will not punch through completely

- Remove a couple of sheets from the back side of the lift of paper and press the punch button again
- Only punch 25 sheets of 20lb copy paper at one time and only 2 sheets of plastic at one time

Punch has stopped with punch pins still in the paper and will not retract on its own

- Turn machine power switch to the “off” position and unplug power cord from the wall.
Remove the black cap from the right side plate of the machine.
Use a flat blade, standard screwdriver to rotate the shaft counter-clockwise.
This will manually retract the punch pins from the paper, continue until all pins have retracted completely.



Troubleshooting

Symptom

Solution

Coil will not spin into book

- Align pages of book such that the holes in the pages are all evenly aligned
- Use book former to shape book to the contour of the coil

Pliers will not crimp coil

- Make sure that the RED dot is pointing up, to the ceiling and the right hand side of the book is being cut/crimped
- Hold pliers horizontally
- Grasp coil being cut firmly between thumb and forefinger will operating pliers

Warranty

The 3250CL coil binding system is covered by a 3 Year Limited Warranty against defects in materials and workmanship, and is limited to the replacement of the defective system or the repair of the defective system at the manufacturing facility. Modifications or intentional abuse of the system will not be covered under this warranty. The punching die assembly will be covered for 1 year to be free of manufacture defects.

To obtain warranty repair of 3250CL coil binding system:

1. Obtain serial number of machine from decal on back of machine as shown below.



2. Call 1-800-390-5782 to arrange for a Return Merchandise Authorization number. Please have the symptom(s) of the machine failure, the machine serial number, as well as shipping and contact information at the time of the call.

Performance Design LLC
Boise, ID.
Web: www.rhin-o-tuff.com
E-mail: pdi@pdibind.com

**25 sheet punching capacity is based upon 25 sheets of 20lb copy paper, punching 44 holes on an 11" paper edge.



STRONG

TUFF AND BUILT TO LAST

• **SIMPLE**

EASY TO USE & MAINTAIN

• **HONEST**

TRUSTWORTHY & SOUND

• **CAPABLE**

NEVER LETS YOU DOWN

